



WALL CONNECTOR, 32A THREE PHASE INSTALLATION MANUAL

Approved Markets: Europe, China, Hong Kong, Australia.

For additional languages, please visit: www.tesla.com/wallconnector



About this Manual.....	2	Connect the Wiring.....	17
Product Specifications.....	2	Set the Operating Current.....	19
Errors or Inaccuracies.....	2	Secure the Cover and Power Up.....	20
Copyrights and Trademarks.....	2		
		Troubleshooting.....	21
Safety Information.....	3	Reset.....	24
Important Safety Instructions.....	3	Questions?.....	25
Warnings.....	3		
Cautions.....	3	Appendix A: Testing for	
Notes.....	4	Proper Operation.....	26
Specifications.....	5	Appendix B: Optional	
		Connection for Load Sharing...27	
Features.....	6	Daisy Chaining Multiple Wall Connectors.....27	
Optional Circuit Ratings.....	6	Example of the Communication Wiring.....28	
Self-Monitoring and Recovery.....	6		
Power Outages.....	6	Appendix C: SRRC (China	
Load Sharing.....	6	only).....	29
Planning Your Installation.....	7	Charging Equipment	
Minimum Requirements.....	7	Limited Warranty.....	30
Service Wiring.....	7	General Terms.....	30
400V Three-Phase With Neutral.....	7	Limits of Liability.....	31
230V Single-Phase With Neutral.....	7	Warranty Enforcement Laws and	
230V Single-Phase Without Neutral.....	8	Dispute Resolution.....	31
230V Three-Phase Without Neutral.....	8	Country-Specific Consumer Disclosures.....	32
Determine the Circuit Breaker			
Requirements.....	8		
Choose the Best Location for the Wall			
Connector.....	8		
Installation Considerations.....	9		
Check the Box Contents.....	11		
Step-by-Step Installation			
Instructions.....	13		
Tools and Materials Required.....	13		
Overview of Installation Steps.....	13		
Install the Low Profile Bracket for Rear			
or Bottom Entry Wiring.....	14		
Install the Top Entry Bracket for Top			
Entry Wiring.....	15		
Prepare for Installation.....	16		



About this Manual

Product Specifications

All specifications and descriptions contained in this document are verified to be accurate at the time of printing. However, because continuous improvement is a goal at Tesla, we reserve the right to make product modifications at any time.

Errors or Inaccuracies

To communicate any inaccuracies or omissions, or to provide general feedback or suggestions regarding the quality of this manual, send an email to:

ownersmanualfeedback@teslamotors.com

Copyrights and Trademarks

All information in this document is subject to copyright and other intellectual property rights of Tesla Motors, Inc. and its licensors. This material may not be modified, reproduced or copied, in whole or in part, without the prior written permission of Tesla Motors, Inc. and its licensors. Additional information is available upon request. The following are trademarks or registered trademarks of Tesla Motors, Inc. in the United States and other countries:













All other trademarks contained in this document are the property of their respective owners and their use herein does not imply sponsorship or endorsement of their products or services. The unauthorized use of any trademark displayed in this document or on the vehicle is strictly prohibited.







Important Safety Instructions



This document contains important instructions and warnings that must be followed when installing and maintaining the Wall Connector.

Warnings

-  Warning: Read all the instructions before using this product.
-  Warning: This device should be supervised when used around children.
-  Warning: The Wall Connector must be grounded through a permanent wiring system or an equipment grounding conductor.
-  Warning: Do not install or use the Wall Connector near flammable, explosive, harsh, or combustible materials, chemicals, or vapors.
-  Warning: Turn off input power at the circuit breaker before installing or cleaning the Wall Connector.
-  Warning: Use the Wall Connector only within the specified operating parameters.
-  Warning: Never spray water or any other liquid directly at the wall mounted control box. Never spray any liquid onto the charge handle or submerge the charge handle in liquid. Store the charge handle in the dock to prevent unnecessary exposure to contamination or moisture.
-  Warning: Stop using and do not use the Wall Connector if it is defective, appears cracked, frayed, broken, or otherwise damaged, or fails to operate.
-  Warning: Do not attempt to disassemble, repair, tamper with, or modify the Wall Connector. The Wall Connector is not user serviceable. Contact Tesla for any repairs or modification.
-  Warning: When transporting the Wall Connector, handle with care. Do not subject it to strong force or impact or pull, twist, tangle, drag, or step on the Wall Connector, to prevent damage to it or any components.

-  Warning: Do not touch the Wall Connector's end terminals with fingers or sharp metallic objects, such as wire, tools, or needles.
-  Warning: Do not forcefully fold or apply pressure to any part of the Wall Connector or damage it with sharp objects.
-  Warning: Do not insert foreign objects into any part of the Wall Connector.
-  Warning: Use of the Wall Connector may affect or impair the operation of any medical or implantable electronic devices, such as an implantable cardiac pacemaker or an implantable cardioverter defibrillator. Check with your electronic device manufacturer concerning the effects that charging may have on such electronic devices before using the Wall Connector.

Cautions

-  Caution: Do not use private power generators as a power source for charging.
-  Caution: Incorrect installation and testing of the Wall Connector could potentially damage either the vehicle's Battery and/or the Wall Connector itself. Any resulting damage is excluded from the New Vehicle Limited Warranty and the Charging Equipment Limited Warranty.
-  Caution: Do not operate the Wall Connector in temperatures outside its operating range of -30°C to +50°C.



Safety Information

Notes

Note: Ensure that the Wall Connector's charging cable is positioned so it will not be stepped on, driven over, tripped on, or subjected to damage or stress.

Note: Do not use cleaning solvents to clean any of the Wall Connector's components. The outside of the Wall Connector, the charging cable, and the connector end of the charging cable should be periodically wiped with a clean, dry cloth to remove accumulation of dirt and dust.

Note: Be careful not to damage the circuit boards or components during installation.

Note: Use a cable sheath or similar containment to cover the supply cables. The color black is recommended.



The maximum power rating for the Wall Connector is 22 kW or 32A at 400V AC three-phase power.

Note: Downloadable versions of this publication and an installation video in languages other than English are available on the Tesla website:

www.tesla.com/wallconnector.

Description	Specifications
Voltage and Wiring	<ul style="list-style-type: none"> • Nominal voltage: <ul style="list-style-type: none"> • 230V AC single-phase: L1, neutral, and earth ground • 230V AC three-phase: L1, L2, L3 and earth ground • 400V AC three-phase: L1, L2, L3, neutral and earth ground • Voltage range: <ul style="list-style-type: none"> • 180V to 264V AC between N and L1 terminals
Current	Maximum 32A
Frequency	50 Hz
Cable Length	2.6 m and 7.4 m
Wall Connector Dimensions	Height: 380 mm Width: 160 mm Depth: 140 mm
Top Entry Bracket Dimensions	Height: 275 mm Width: 130 mm Depth: 50 mm
Weight (including bracket)	9 kg
Operating Temperature	-30°C to 50°C
Storage Temperature	-40°C to 85°C
Enclosure Rating	IP 44: indoor and outdoor use
Agency Approvals	CE



Optional Circuit Ratings

Use a three-phase circuit breaker rated for 32A per phase to obtain the fastest charging. In certain installation locations, this level of power isn't readily available. Therefore, you can adjust the circuit breaker rating on the Wall Connector from 6A to 32A (refer to Set the Operating Current on page 19).

Note: Tesla vehicles must be configured with optional onboard charging equipment to accept higher amperages. Contact Tesla if you have questions about the onboard charging capabilities of your vehicle.

Self-Monitoring and Recovery

The Wall Connector has a ground monitoring circuit that continuously checks for the presence of a safe ground connection and automatically recovers from faults. Manual testing and resetting is not required.

Temporary problems such as ground faults or utility power surges are overcome automatically. If a residual current fault occurs that interrupts charging, the Wall Connector automatically tries to clear the fault and re-attempt charging.

If the problem is immediately sensed a second time, the Wall Connector waits 15 minutes before trying to charge. This process repeats 4 times and if all attempts are unsuccessful, power is removed and no further attempts are made. In this case, you will see a red error light on the front panel (refer to Troubleshooting on page 21). It is recommended that when you see a red error light, you power off the Wall Connector by switching off the upstream circuit breaker, and then power it back on again.

The Wall Connector can alternatively be reset when a red error light is encountered using the RESET button (refer to Reset on page 24).

Power Outages

If a power outage occurs, the Wall Connector automatically resumes charging when power is restored. If the charging cable is plugged into the vehicle when power is restored, the lights blink and the unit does not energize the charging cable for approximately 15 seconds to three minutes. This prevents the utility grid from experiencing a large surge when power is restored and allows vehicles to begin drawing current at random times, rather than all at once.

Load Sharing

The Wall Connector provides the capability to wire 4 Wall Connectors to a single circuit, giving vehicle owners reassurance that they can charge multiple vehicles at home (refer to Appendix B: Optional Connection for Load Sharing on page 27).



Minimum Requirements

Installation of the Wall Connector requires that you:

- Calculate the existing electrical load to determine the maximum operating current.
- Calculate the distance to ensure minimal voltage drop.
- Obtain any necessary permits from the local authority that has jurisdiction and confirm that the follow-up inspection has been scheduled by an electrician after the installation is complete.
- Use only copper conductors.
- Use conductors that are sized in accordance with local wiring regulations. The selected cable must be able to sustain periods of constant load of up to 40A.
- Use protective devices. The circuit protection device chosen must incorporate a suitable residual-current device (RCD) and overcurrent protection in relation to the electrical load selected.

Note: Consult with an electrician to ensure that the installation meets local regulations.

Service Wiring

400V Three-Phase With Neutral

For three-phase use of a Wye-connected secondary, all three phases (L1, L2, and L3) and neutral should be connected. Each phase voltage should measure 230V to neutral.

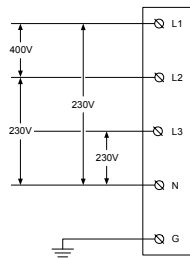

230V Single-Phase With Neutral

For single-phase use of a Wye-connected secondary, only a single-phase (L1) and neutral should be connected. This phase voltage should measure 230V between line and neutral.

Warning: The Wall Connector in this configuration operates only from a single-phase (L1). Do not connect the remaining phases (L2 and L3).

Warning: Before installing the Wall Connector, identify the type of utility service connection available on site. If you are unsure about the type of connection available at the service panel, consult an electrician, or contact Tesla for assistance.

Note: Consult with your local electrician or refer to your local code for proper wire sizing appropriate for the currents in your Wall Connector.

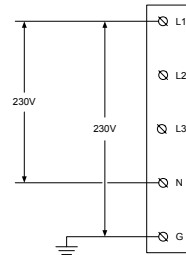



Planning Your Installation

230V Single-Phase Without Neutral

For installations without a neutral and 230V from line to line, connect any two lines (L1, L2, or L3 in the illustration) to the L1 and neutral positions on the Wall Connector terminal block.

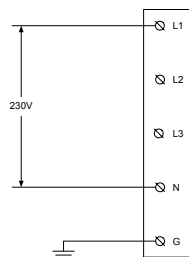

230V Three-Phase Without Neutral

Connect the first phase (L1 in the illustration) to the L1 position on the terminal block. Connect the next phase (L2 in the illustration) to the L2 position on the terminal block. Finally connect the third phase (L3 in the illustration) to the N position on the terminal block.

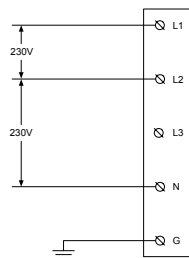

Note: This configuration should only be used with Tesla vehicles.

Note: Phase sequence is irrelevant.

Determine the Circuit Breaker Requirements

To determine the type of upstream circuit breaker you need, examine the distribution panel or circuit breaker box to identify the amperage available at the installation site.

The Wall Connector has an internal rotary switch that allows you to adjust its operating current (refer to Set the Operating Current on page 19). The circuit breaker should be rated for the continuous current of: 6, 8, 10, 13, 16, 20, 25, or 32A.

Choose the Best Location for the Wall Connector

Determine the parking location of the vehicle to ensure that the charge cable reaches the charge port. The Wall Connector should be located:

- In an enclosed garage, typically on the vehicle's charge port side.
- In a well-ventilated area. Avoid installation in an enclosed box, or adjacent to hot appliances.
- 1.2 m above the floor.
- 190 mm from any obstructions to allow for cable looping.

Note: The Wall Connector is approved for outdoor use, but it is not designed for complete immersion in liquid. Protection from rain is recommended but not required.



Installation Considerations

Three methods are available to install the Wall Connector. The location of the conduit determines which installation method to follow. If the conduit runs along the floor or low on the wall, use the bottom entry configuration. If the conduit comes from inside the wall, use the rear entry configuration. If the available conduit comes from the ceiling, use the top entry installation.

Note: Throughout the manual, “conduit” is used as the standard term for the protective tubing that houses the service wiring. In regions where conduit is not used (Europe for example), a cable comprised of service wiring enclosed in a protective jacket may be substituted for conduit if allowed by local regulations.

Here are some additional guidelines:

- Conduit openings are sized for 32 mm conduit.
- Use an appropriate circuit breaker.
- To keep the housing weatherproof, use cable glands.

Bottom or Rear Entry





Planning Your Installation

Top Entry



Check the Box Contents



The shipping box contains parts for all installation methods, as well as this manual. If any parts are damaged or missing, contact Tesla (refer to Questions? on page 25).

Note: Downloadable versions of this publication and an installation video in languages other than English are available on the Tesla website: www.teslamotors.com/wallconnector.

Note: Not shown is the supplied cardboard template.

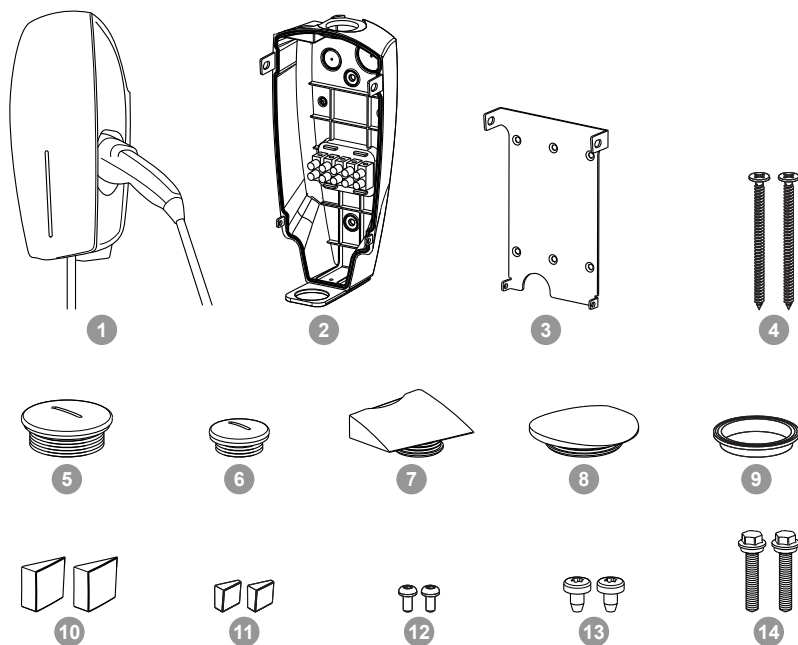

Item	Description (Quantity)
1	Wall Connector
2	Top entry bracket*
3	Low profile bracket **
4	Low profile bracket screws (2) **
5	Bottom or rear entry power conduit plug
6	Bottom or rear entry signal conduit plug
7	Top entry signal conduit plug*
8	Top entry power conduit plug*
9	Bottom conduit sealing gasket*
10	Top bracket-to-housing screw covers (2)



Check the Box Contents

Item	Description (Quantity)
11	Bottom bracket-to-housing screw covers (2)
12	Bottom bracket-to-housing screws (2)
13	Top bracket-to-housing screws (2)
14	Top entry bracket mounting screws (2)*
* Items used in only top entry installations.	
** Items used in only bottom or rear entry installations.	



Tools and Materials Required

Before installing the Wall Connector, gather the following tools and materials:

- Pencil or marker
- Hole punch (optional, to push through cardboard template)
- Wire stripper
- Voltmeter or digital multimeter (to measure AC voltage at the installation site)
- Phillips screwdriver
- Small flathead screwdriver
- Large flathead screwdriver (optional, to remove plastic knock-outs)
- T20 security pin Torx driver
- T10 Torx driver
- M20 and M32 cable glands (also known as sealing hubs)
- Ferrules (the diameter of the ferrule depends on the diameter of the power wiring and the construction)
- Wiring (use twisted pair communication cable (Max diameter: 1.02 mm; Max cross-sectional area: 0.82 mm²) for a maximum of 15 m between Wall Connectors)
- Level
- Machine drill
- Torque driver (for terminal block connections)

Overview of Installation Steps

 **Warning:** After you run service wiring to the installation site using metal flame retardant conduit, install the appropriate upstream circuit breaker, **TURN OFF AND VERIFY POWER IS OFF BEFORE CONTINUING.**

Then follow these steps to install the Wall Connector:

- Install the Low Profile Bracket for Rear or Bottom Entry Wiring on page 14
- Install the Top Entry Bracket for Top Entry Wiring on page 15
- Prepare for Installation on page 16
- Connect the Wiring on page 17
- Set the Operating Current on page 19
- Secure the Cover and Power Up on page 20



Step-by-Step Installation Instructions

Install the Low Profile Bracket for Rear or Bottom Entry Wiring

Use the low profile bracket, shown below, to wire the Wall Connector from the rear or bottom.



1. Use the low profile bracket as a guide to mark the location on the wall for the mounting screws.

- Use a level to ensure that the marks are perfectly vertical.
- Space the holes 114 mm apart.

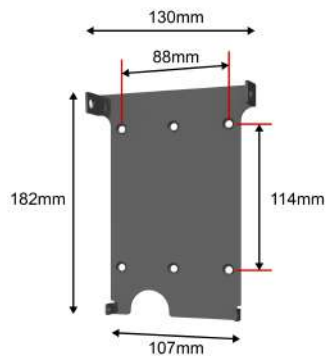

- Position the bracket so that the Wall Connector is located at a maximum of 150 cm from floor level. The minimum height is 45 cm if mounting indoors, and 122 cm if mounting outdoors.

- If using rear entry conduit, use at least one set of the edge mounting holes so that the conduit does not interfere with the wall stud.
- If using bottom entry conduit, use the center two mounting holes.

Note: Ensure that the minimum and maximum height of the bracket is carefully selected. It should be installed out of the way of any reasonably foreseeable impacts.

2. Attach the bracket using fasteners that are appropriate for the type of wall material, drilling pilot holes if necessary. Use the supplied screws only if mounting the bracket directly to a wooden stud. If mounting to another type of wall (hollow, masonry, etc.), use fasteners that are long enough to securely anchor the Wall Connector and can hold at least 36 kg.

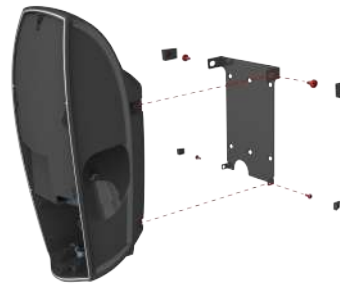



Install the Top Entry Bracket for Top Entry Wiring

The top entry bracket enables you to route the service wiring into the Wall Connector enclosure from the top of the enclosure, as shown below.



1. Use the cardboard template and a level as a guide to mark the location on the wall for the mounting screws.

- Use a level to ensure that the marks are perfectly vertical.
- Space the holes 155 mm apart.
- Position the bracket so that the Wall Connector is located at a maximum of 150 cm from floor level. The minimum height is 45 cm if mounting indoors, and 122 cm if mounting outdoors.

Note: Ensure that the minimum and maximum height of the bracket is carefully selected. It should be installed out of the way of any reasonably foreseeable impacts.

2. (Optional) There are two additional mounting holes. To use these holes, use a flat-head screwdriver to knock-out the plastic that is closing the holes. These holes are spaced 70 mm apart.



3. Attach the bracket using fasteners that are appropriate for the type of wall material, drilling pilot holes if necessary. Use the supplied screws only if mounting the bracket directly to a wooden stud. If mounting to another type of wall (hollow, masonry, etc.), use fasteners that are long enough to securely anchor the Wall Connector and can hold at least 36 kg.

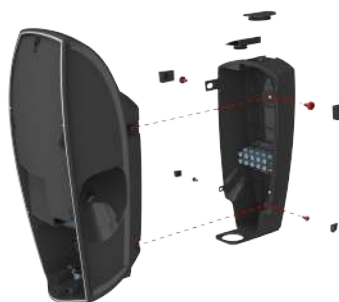



Step-by-Step Installation Instructions

Prepare for Installation

Follow these instructions to remove the cover and route the service wiring into the Wall Connector.

1. Use a T10 Torx driver to remove the screw at the bottom of the outer cover. Carefully disengage the snaps on the sides and top using a flathead screwdriver and completely remove the cover. Save the screw and cover for reassembly.



2. Use a T20 security pin Torx driver to remove the six screws on the sealing cover. Carefully remove the sealing cover and disconnect the ribbon cable. Save the screws and cover for reassembly.



⚠ Caution: Do not allow the sealing cover to hang from the ribbon cable. Doing so can damage the ribbon cable or its connectors.

3. For top entry configuration, install the wiring to the terminal block in the top entry bracket as shown in Connect the Wiring on page 17, then return to this section and proceed to the next step. For back or bottom entry configurations, skip to the next step.
4. Place and hold the Wall Connector on the bracket, ensuring that all four mounting tabs are properly aligned.
5. Use a T20 Torx driver to install the two top housing mounting screws. Push the cosmetic screw covers into place.
6. Use a T20 Torx driver to install the two bottom housing mounting screws. Push the cosmetic screw covers into place.



Connect the Wiring

Note: Consult with your local electrician or refer to your local code for proper wire sizing appropriate for the currents in your Wall Connector.

Note: It is the installer's responsibility to identify whether additional grounding is required to ensure that local regulations are met. Grounding must be installed at the power source and not at the cable entry to the Wall Connector.

Note: For three-phase wiring, connect the terminal block with the L1, L2, L3, neutral, and ground.

⚠ Warning: Do not connect service wiring until you have read and fully understand the concepts described in Service Wiring on page 7.

1. Turn off the power.

⚠ Warning: RISK OF ELECTRIC SHOCK! Before continuing, use a voltmeter to ensure the power is off by confirming that NO VOLTAGE is present at the service wiring or terminals.

2. For top entry installation, pull the service wiring into the top entry bracket or the Wall Connector. Use an M32 cable gland to seal the power conduit or cable.

Note: The meaning of wiring colors might vary from country to country. Follow all applicable national and local regulations concerning wiring color codes.

The following illustration shows an example of the wiring for the top entry bracket.

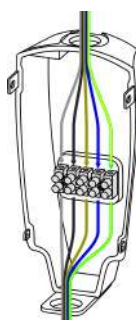

The following illustration shows an example of the wiring for the low profile bracket.



3. Strip the service wires going to the terminal block on the top entry bracket 8 mm. Ferrules are recommended.

Note: For top entry installation, the flexible pre-installed wires that go from the top entry bracket to the housing are already terminated and do not need to be stripped.

4. Lead the preconnected service wires in the main housing and connect the preconnected service wires to the main terminal block (cross section: 10 mm, diameter: 3.6 mm) with L1, L2, L3, neutral, and ground wires going to the locations shown in the following illustration.

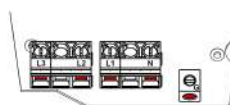

⚠ Caution: Cut each of the wire strands and insert them fully into each the terminal block.



Step-by-Step Installation Instructions

Note: To ensure proper operation, verify that neutral is connected to the neutral line inside the circuit breaker box or the main electrical panel.

5. Tighten the terminal block to the recommended torque:
 - 1.5 N-m for the terminal block on the top entry bracket.
 - 1.2 N-m for the terminal block in the main housing.
 - 2.0 N-m for the ground terminal block in the main housing.
6. Check for miswiring using a multimeter and verify that there are no shorts before turning the upstream circuit breaker ON.



Set the Operating Current

Follow these instructions to configure the DIP switch. The following illustration shows an enlarged view of the DIP and rotary switches.



⚠ Warning: Power **MUST** remain OFF before setting or changing the DIP or rotary switches. Changing these switches with the power ON will not be recognized by the system and is dangerous due to the risk of electric shock.

1. Turn OFF power.
2. Use a non-conductive object to adjust the DIP switch settings:

- Switch Position 1:
 - If the grounding scheme is TN or TT, set the DIP switch DOWN.
 - If the grounding scheme is IT, set the DIP switch UP (the ON position).

⚠ Warning: Before you set the DIP switches, confirm which type of input service the utility provides.

- Switch Position 2:
 - DIP Switch Position 2 should always be in the UP position.

Wiring/Connection	DIP Switch Position
IT	
TT-TN	

3. Set the rotary switch for the appropriate current setting supported by your circuit breaker. Typical circuit breaker ratings are: 6A, 8A, 10A, 13A, 16A, 20A, 25A and 32A.

Use a small flathead screwdriver to adjust the rotary switch to the appropriate circuit breaker capability setting. The corresponding rotary switch settings for the typical circuit breakers are shown in the following table:



Step-by-Step Installation Instructions

Rotary Switch Position	Maximum Output Current
0	Test mode
1	6A
2	8A
3	10A
4	13A
5	16A
6	20A
7	25A
8	32A
9	Not a valid selection
A	Not a valid selection
B	Not a valid selection
C	Not a valid selection
D	Not a valid selection
E	Not a valid selection
F	Slave mode

4. Reattach the ribbon cable to the sealing cover.
5. Reinstall the sealing cover. Use a T20 security pin Torx driver to lightly secure the sealing cover by installing only the top screw.
6. Turn ON power.
7. If the installation is successful, the LEDs briefly sequentially illuminate green with a pattern that ends with the top green LED staying solid ON. If there is a solid or flashing red LED, refer to Troubleshooting on page 21 and resolve the error before you continue.
Note: To review the pattern of blinking lights, press and hold the RESET button for 5 seconds.
8. Turn OFF power.
9. Write the contact information of the installer on the label on the inside of the Wall Connector.

Secure the Cover and Power Up

1. Use a T20 security pin Torx driver to install the remaining screws on the sealing cover. Ensure that the cover is properly aligned before fully tightening the screws.
2. Attach the outer cover to the sealing cover starting with the latch at the top. Engage the snaps on the sides and align the mounting tab with the housing at the bottom.



3. Use a T10 Torx driver to install the screw that secures the bottom of the outer cover to the housing.
4. Close any unused openings with power and signal conduit plugs.
Note: There should not be any visible openings to the inside of the Wall Connector, and the Wall Connector should be completely sealed from the environment.
5. Turn ON the power. The installation is correct if the LEDs go through a sequence of flashing, ending with the top Green LEDs staying solidly ON. If there is a solid or flashing Red LED, resolve the error before you continue (refer to Troubleshooting on page 21).
Note: To review the pattern of blinking lights, press and hold the Reset button for 5 seconds.
6. Attempt to charge the vehicle to ensure the Wall Connector is operating correctly and charging at the selected operating current. For instructions on how to charge, refer to the owner information provided with the vehicle.



Green Lights	Yellow Light	Red Light	Auto-Retry	What it Means	What to Do
Top light on	Off	Off	Not applicable	Power on. The Wall Connector is powered and in standby but not charging the vehicle.	Not applicable.
Streaming lights	Off	Off	Not applicable	The Wall Connector is charging the vehicle.	Not applicable.
Streaming lights	1 flash	Off	Not applicable	Charging current is reduced due to high temperature detected in the Vehicle Connector.	Make sure the connector is fully inserted into the charge inlet in the vehicle's charging port, is not covered by anything, and there is no heat source is nearby. If the problem persists in normal ambient temperatures (under 38°C), contact Tesla.
Streaming lights	2 flashes	Off	Not applicable	Charging current is reduced due to high temperature detected in the wall plug or on the input terminals to the Wall Connector.	If the Wall Connector is plugged into a wall outlet, make sure that it is fully inserted into the receptacle, it is not covered by anything, and there is no heat source nearby. If the Wall Connector is hard-wired, make sure it is not covered by anything, and there is no heat source nearby. If the problem persists in normal ambient temperatures (under 38°C), contact Tesla.
Streaming lights	3 flashes	Off	Not applicable	Charging current is reduced due to high temperature detected inside the Wall Connector.	Make sure the Wall Connector is not covered by anything and there is no heat source nearby. If the problem persists in normal ambient temperatures (under 38°C), contact Tesla.



Troubleshooting

Green Lights	Yellow Light	Red Light	Auto-Retry	What it Means	What to Do
Off	Off	1 flash	After 15 minutes and up to 4 times	Ground fault. Current is leaking through an unsafe path. Possible Line to ground or Neutral to ground fault.	Try again by disconnecting the Wall Connector from the vehicle and reconnecting. If the problem persists, turn OFF the circuit breaker servicing the Wall Connector, wait 10 seconds, turn the circuit breaker ON again, then try reconnecting the Wall Connector to the vehicle. If the problem persists, contact Tesla.
Off	Off	2 flashes	After 1 minute and up to 4 times	No ground connection detected in the Wall Connector.	Make sure the Wall Connector is properly grounded. If uncertain, consult your electrician to ensure proper grounding at your circuit breaker or power distribution box and that appropriate connections are made to the Wall Connector.
Off	Off	3 flashes	No	Input miswired: possibly Line and Neutral are swapped.	The wiring between the wall power and the Wall Connector has been incorrectly installed. Consult your electrician.
Off	Off	4 flashes	After 1 minute and up to 4 times	Over or under voltage protection.	Consult your electrician to ensure appropriate voltage on the circuit breaker that services the Wall Connector.



Green Lights	Yellow Light	Red Light	Auto-Retry	What it Means	What to Do
Off	Off	5 flashes	After 1 minute retry (no limit on retries)	Over current protection.	Reduce the vehicle's charge current setting. If the problem persists and the attached vehicle is manufactured by Tesla, contact Tesla. If the problem persists and if the attached vehicle is not manufactured by Tesla, contact the original manufacturer.
Off	Off	6 flashes	After 1 minute retry (no limit on retries)	A communication error occurred between the Wall Connector and the vehicle.	If possible, plug the vehicle into another Wall Connector or a Mobile Connector to determine if the vehicle is able to communicate with other charging equipment. Then contact Tesla Service.
Top light on	Off	1 flash	No	Over temperature protection (latch-off)	Make sure the Wall Connector, vehicle connectors, and wall plug (if used) are not covered by anything and there is no heat source nearby. If the problem persists in normal ambient temperatures (under 38°C), contact Tesla.
Top light on	Off	2 flashes	No	Non-Tesla vehicle attempting connection to non-compatible input distribution.	Compatible input distributions are: single-phase distribution or 400V, three-phase distribution.
Top light on	Off	3 flashes	No	Incorrect rotary switch setting.	Consult your electrician.



Troubleshooting

Green Lights	Yellow Light	Red Light	Auto-Retry	What it Means	What to Do
Top light on	Off	4 flashes	Not Applicable	Circuit Breaker Sharing Network: More than one Wall Connector is set to Master.	Only one Wall Connector can be set to a master configuration. All other linked Wall Connectors must be set to slave (position F). Set one of the Wall Connectors to Slave.
Top light on	Off	5 flashes	Not Applicable	Circuit Breaker Sharing Network: More than three Wall Connectors are set to Slave.	Move one or more Wall Connectors to a different circuit and disconnect it from this Circuit Breaker Sharing Network.
Top light on	Off	6 flashes	Not Applicable	Circuit Breaker Sharing Network: The networked Wall Connectors have different maximum current capabilities.	Contact Tesla.
Off	Off	Solid red	No	Wall Connector hardware failure. Possible failures include the following: <ul style="list-style-type: none">• Contactor failed• Self test failed in CCID circuitry• Other possible hardware failures might be MCU, 3V3output, or the thermal sensor.	Contact Tesla.

Reset

If a fault causes a RED error light to illuminate or flash and the fault condition is corrected, you use RESET the Wall Connector to resume normal operation. There are two ways to RESET the Wall Connector:

- Press the RESET button for two to three seconds until the top lights changes from RED to GREEN. This clears the fault message but does not reboot the Wall Connector.
- In a rare situation, you might need to force the Wall Connector to reboot without recycling the input power. Hold the RESET button for five seconds. When the top light changes from RED to GREEN, release the RESET button. The top light should continue to illuminate GREEN. If the light returns to flashing RED, the fault state has not been corrected.



Questions?

- Europe:
 - ChargingInstallation-EUR@tesla.com
 - <http://teslamotors.com/callEU>



Appendix A: Testing for Proper Operation

1. Turn OFF power.

⚠ Warning: RISK OF ELECTRIC SHOCK!
Before continuing, use a voltmeter to ensure the power is off by confirming that NO VOLTAGE is present at the service wiring or terminals.

2. Use a non-conductive object to adjust the DIP switches to the appropriate grid setting and circuit breaker sharing setting (refer to Set the Operating Current on page 19).
3. Use a small flathead screwdriver to set the rotary switch to position "0" to put the Wall Connector into Test Mode.



⚠ Warning: Power MUST remain OFF before setting or changing the DIP or rotary switches. Changing these switches with the power ON will not be recognized by the system and is dangerous due to the risk of electric shock.

4. Reattach the ribbon cable to the sealing cover.
5. Use a T20 security pin Torx driver to lightly secure the sealing cover by installing only the top screw.
6. Turn ON the circuit breaker.
7. Watch for any Red LEDs to be ON after a sequence of LED display; if so, there is a fault in the installation.
8. Listen for the click of a contactor or relay closing and opening.
9. Watch for Green streaming LEDs (for 5 seconds).

LEDs will revert to top Green LED ON and Red LEDs flashing (3 times).

Note: To review the pattern of blinking lights, press and hold the Reset button for 5 seconds.

10. Turn OFF the circuit breaker.
11. Remove the sealing cover screw, sealing cover. Disconnect the ribbon cable.

⚠ Caution: Do not allow the sealing cover to hang from the ribbon cable. Doing so can damage the ribbon cable or its connectors.

12. Reposition the rotary switch to the appropriate setting (refer to Set the Operating Current on page 19).
13. Reattach the ribbon cable to the sealing cover.
14. Replace all the screws and reinstall the outer cover (refer to Secure the Cover and Power Up on page 20).



The Wall Connector includes a feature whereby Wall Connector to Wall Connector communication allows you to split the maximum available load over a maximum of 4 Wall Connectors. The wire used for this local network must share the main power cable conduit or be housed in a separate conduit.

You can connect the Wall Connectors in series in a daisy chain configuration.

Note: Take additional precautions into consideration to prevent water ingress at the Wall Connectors when installing them outdoors.

Note: Consult with an electrician to ensure that the installation meets local regulations.

Daisy Chaining Multiple Wall Connectors

Each Wall Connector has one terminal block dedicated for the communication wiring as shown below. The left hand side of the terminal block is the input terminal and the right hand side the output terminal.

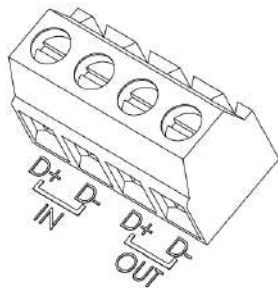

1. Form a daisy-chained network by connecting the cables from OUT to IN and

always from positive to positive and negative to negative between each of the participating Wall Connectors (refer to Example of the Communication Wiring on page 28).

- The signal wires between each Wall Connector should run in signal conduit. Use an M20 UL approved conduit hub to seal the signal conduit opening.
 - If the signal wire is routed in the power conduit with the power wires, the insulation rating of the signal wire should be equal to or greater than that of the power wires.
 - The maximum distance between Wall Connectors is 15 m.
 - Use twisted pair cable (Max diameter: 1.02 mm; Max cross sectional area: 0.82 mm²) for the signal wire. Make sure to select the appropriate type of cable depending on the location of the installation (indoor / outdoor).
2. Set one Wall Connector as the master by setting the Rotary Switch Position from 1 through D, depending on the maximum available output current. Set up to 3 Wall Connectors as slaves by setting the Rotary Switch Positions to F. In the load sharing network, only one unit can be designated as the master (refer to Set the Operating Current on page 19).
 3. Confirm that the load sharing network is properly installed by observing the LED indicators in the Wall Connector. When starting up the circuit breaker for the first time, green lights turning ON for 5 seconds indicate a proper installation. The final display is:

Green Lights	Yellow Light	Red Light	What it Means...
On (top and bottom)	Off	Off	Master unit
On (bottom)	Off	Off	Slave unit



Appendix B: Optional Connection for Load Sharing

Example of the Communication Wiring

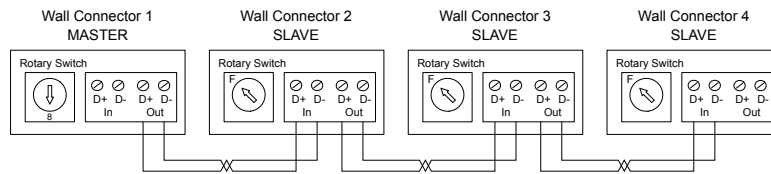

IEC 60364 - 7-722 2015 standards specifies:

- Every Wall Connector needs to be equipped with a separate device against overcurrent and with an own RCD. This applies for an installation of a single Wall Connector as well as for all units involved in a load sharing installation.

Note: This also applies for China, Hong Kong and Macau.

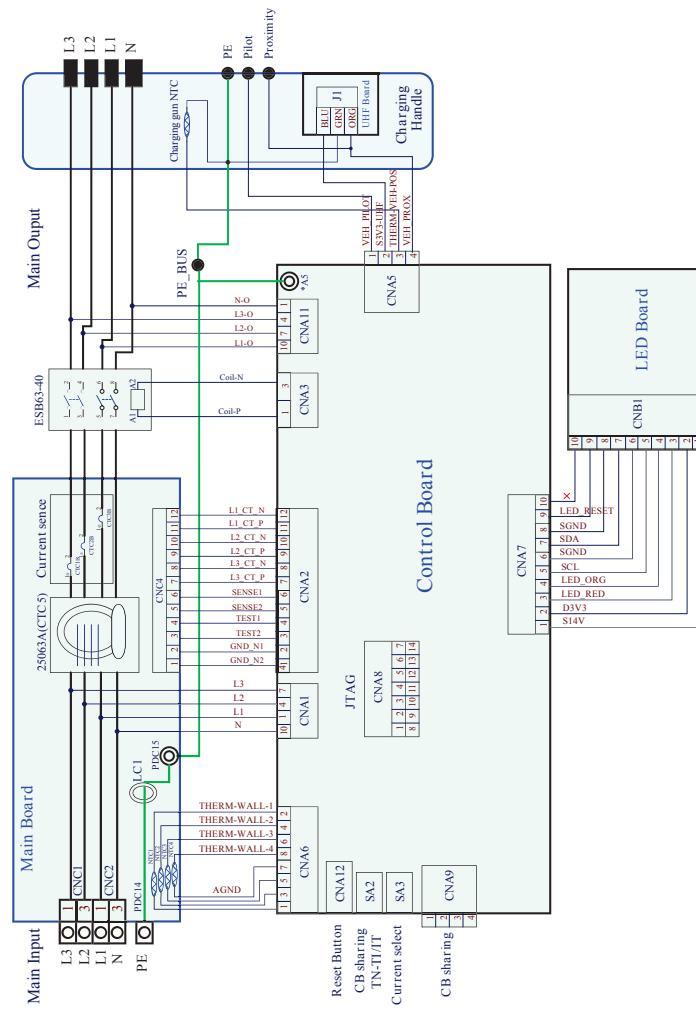



Charging Equipment Limited Warranty

General Terms

Subject to the exclusions and limitations described below, the Charging Equipment Limited Warranty covers the refund, repair or replacement necessary to remedy any manufacturing defects in Tesla manufactured and supplied Wall Connector that occur under normal use for a period of 48 months, and Mobile Connector or charging adapter that occur under normal use for a period of 12 months (or 24 months in EU member states) from the date of invoice to the customer. Any Tesla connector or adapter included in the initial purchase and delivery of a Tesla vehicle by Tesla is covered under the Basic Vehicle Limited Warranty section of the New Vehicle Limited Warranty for 4 years or 80,000 km, whichever comes first, subject to the terms and conditions of the New Vehicle Limited Warranty.

You may also have other legal rights and remedies conveyed by your local laws (which may vary by country) in addition to the rights and remedies provided to you under this Charging Equipment Limited Warranty. For any additional provisions which relate to your territory, please see "Country-Specific Consumer Disclosures" provided at the end of this document.

This Charging Equipment Limited Warranty does not cover any damage or malfunction directly or indirectly caused by, due to, or resulting from, normal wear or deterioration, abuse, misuse, negligence, accident, lack of or improper use, maintenance, storage or transport, including, but not limited to, any of the following:

- Failure to follow the instructions, maintenance and warnings published in the documentation supplied with your Tesla connector or adapter;
- External factors, including but not limited to, objects striking the Tesla connector or adapter, faulty or damaged electrical wiring, junction boxes, circuit breakers, receptacles or power outlets, the environment or an act of God, including, but not limited to, fire, earthquake, water, lightning and other environmental conditions;
- General appearance or damage to paint, including chips, scratches, dents and cracks;
- Failure to contact Tesla upon discovery of a defect covered by this Charging Equipment Limited Warranty;
- Any repair, alteration or modification to the Tesla connector or adapter or any part, or the installation or use of any parts or accessories, made by a person or facility not authorized or certified to do so;
- Lack of or improper repair or maintenance, including use of non-genuine Tesla accessories or parts; and
- Use for commercial purposes.

Although Tesla does not require you to perform all maintenance, service or repairs at a Tesla Service Center or Tesla authorized repair facility, this Charging Equipment Limited Warranty may be voided, or coverage may be excluded, due to lack of or improper maintenance, service or repairs. Tesla Service Centers and Tesla authorized repair facilities have special training, expertise, tools and supplies with respect to Tesla connectors and adapters and, in certain cases, may employ the only persons, or be the only facilities authorized or certified to work on Tesla connectors and adapters. Tesla strongly recommends that you have all maintenance, service and repairs done at a Tesla Service Center or Tesla authorized repair facility in order to avoid voiding, or having coverage excluded under, this Charging Equipment Limited Warranty.



Limits of Liability

This Charging Equipment Limited Warranty is the only express warranty made in connection with your Tesla connector or adapter. Implied and express warranties and conditions arising under applicable local laws, federal statute or otherwise, in law or in equity, if any, including, but not limited to, implied warranties and conditions of merchantability or merchantable quality, fitness for a particular purpose, durability, or those arising by a course of dealing or usage of trade, are disclaimed to the fullest extent allowable by your local law, or limited in duration to the term of this Charging Equipment Limited Warranty. To the fullest extent allowable by your local law, the performance of necessary repairs and/or replacement of new, reconditioned, or remanufactured parts by Tesla for the covered defects is the exclusive remedy under this Charging Equipment Limited Warranty or any implied warranties. To the maximum extent permissible under your local law, liability is limited to the reasonable price for repair or replacement of the applicable Tesla connector or adapter, not to exceed the manufacturer's suggested retail price. Replacement may be made with parts of like kind and quality, including non-original manufacturer's parts, or reconditioned or remanufactured parts, as necessary.

Tesla shall not be liable for any defects under this Charging Equipment Limited Warranty that exceed the fair market value of the applicable Tesla connector or adapter at the time immediately preceding the discovery of the defect. In addition, the sum of all benefits payable under this Charging Equipment Limited Warranty shall not exceed the price you paid for the applicable Tesla connector or adapter.

Tesla does not authorize any person or entity to create for it any other obligations or liability in connection with this Charging Equipment Limited Warranty. The decision of whether to repair or replace a part or to use a new, reconditioned or remanufactured part will be made by Tesla, in its sole discretion.

To the maximum extent permissible under local law, Tesla hereby disclaims any and all indirect, incidental, special and consequential damages arising out of, or relating to, the Tesla connector or adapter, including, but not limited to, transportation to and from a Tesla Authorized Service Center, loss of the Tesla connector or adapter, loss of vehicle value, loss of time, loss of income, loss of use, loss of personal or commercial property, inconvenience or aggravation, emotional distress or harm, commercial loss (including but not limited to lost profits or earnings), towing charges, bus fares, vehicle rental, service call charges, gasoline expenses, lodging expenses, damage to tow vehicle, and incidental charges such as telephone calls, facsimile transmissions, and mailing expenses.

The above limitations and exclusions shall apply whether your claim is in contract, tort (including negligence and gross negligence), breach of warranty or condition, misrepresentation (whether negligent or otherwise) or otherwise at law or in equity, even if Tesla is advised of the possibility of such damages or such damages are reasonably foreseeable.

Nothing in this Charging Equipment Limited Warranty shall exclude, or in any way limit, Tesla's liability, for death or personal injury solely and directly caused by Tesla's negligence or that of its employees, agents or sub-contractors (as applicable), fraud or fraudulent misrepresentation, or any other liability to the extent the same is proven in a court of competent jurisdiction in a final nonappealable judgment and may not be excluded or limited as a matter of local law.

Warranty Enforcement Laws and Dispute Resolution

To the fullest extent allowed by local law, Tesla requires that you first provide written notification of any manufacturing defect within a reasonable time, and within the applicable coverage period specified in this Charging Equipment Limited Warranty, and allow Tesla an opportunity to make any needed repairs. Please send written notification on dispute resolution to the following address:

Tesla Motors Netherlands B.V.
Atlasstraat 7-9, 5047 RG



Charging Equipment Limited Warranty

Tilburg, Netherlands
Attention: Vehicle Service

Please include the following information:

- Tesla connector or adapter invoice date;
- Your name and contact information;
- Name and location of the Tesla Store and/or Tesla Service Center nearest you;
- Description of the defect; and
- History of the attempts you have made with Tesla to resolve the concern, or of any repairs or services that were not performed by Tesla.

In the event any disputes, differences or controversies arise between you and Tesla related to this Charging Equipment Limited Warranty, Tesla will explore all possibilities for an amicable settlement.

- c. whether an alternative remedy could be offered to the consumer without significant inconvenience thereto.

Country-Specific Consumer Disclosures

Bulgaria

The Charging Equipment Limited Warranty does not modify, affect or substitute your rights under Bulgarian statutory consumer protection laws. The provisions related to your statutory rights are reproduced below:

Consumers' Protection Act:

Article 112

1. In the case of a lack of conformity of the consumer goods with the contract of sale, the consumer shall be entitled to address a complaint, requesting the seller to bring the goods into conformity with the contract of sale. In such case, the consumer may choose either repair or replacement of the goods by new goods, unless this is impossible or the remedy chosen by the consumer is disproportionate in comparison with the other remedy.
2. A remedy shall be deemed to be disproportionate if it imposes costs on the seller which, in comparison with the alternative remedy, are unreasonable, taking into account:
 - a. the value that the consumer goods would have if there were no lack of conformity;
 - b. the significance of the lack of conformity;



Article 113

1. (New, SG No. 18/2011) Where the consumer goods are not in conformity with the contract of sale, the seller shall be obligated to bring the said goods in conformity with the contract of sale.
2. (Renumbered from Paragraph (1), SG No. 18/2011) Consumer goods shall be brought into conformity with the contract of sale within one month after the date on which the complaint was addressed by the consumer.
3. (Renumbered from Paragraph (2), amended, SG No. 18/2011) Upon expiry of the time limit referred to in Paragraph (2), the consumer shall be entitled to have the contract of sale rescinded and to reimbursement of the sums paid or to have a reduction made in the price of the consumer goods according to Article 114 herein.
4. (Renumbered from Paragraph (3), SG No. 18/2011) The consumer goods shall be brought into conformity with the contract of sale free of charge for the consumer. The consumer shall not be liable for any costs incurred for the dispatch of the consumer goods or any costs of material and labour costs associated with the repair of the goods, and must not sustain significant inconvenience.
5. (Renumbered from Paragraph (4), SG No. 18/2011) The consumer may furthermore seek compensation for damage resulting from the lack of conformity.

Article 114

1. In the case of a lack of conformity of the consumer goods with the contract of sale and where the consumer is not satisfied with the settlement of the complaint under Article 113 herein, the consumer shall be entitled to choose between one of the following options:
 - a. 1. rescission of the contract and reimbursement of the sum paid thereby;
 - b. 2. reduction of the price.
2. The consumer shall not be entitled to claim reimbursement of the sum paid or reduction of the price of the goods where the trader agrees to a replacement of the consumer goods with new ones or to repair the consumer goods within one

month after the complaint was addressed by the consumer.

3. The consumer shall not be entitled to claim rescission of the contract if the lack of conformity of the consumer goods with the contract is minor.

Article 115

1. The consumer may exercise the right thereof under this Section within two years as from the time of delivery of the consumer goods.
2. The period referred to in Paragraph (1) shall be interrupted during the time needed to repair or replace the consumer goods or to reach a settlement of the dispute between the seller and the consumer.
3. The exercise of the right of the consumer under Paragraph (1) shall not be subject to any period of limitation for the bringing of action for compensation other than the period referred to in Paragraph (1).

France

The Charging Equipment Limited Warranty does not modify, affect or substitute the statutory rights you have under applicable laws in France. Tesla remains responsible for defects pursuant to articles 1641 to 1649 of the French civil code and in case of a lack of conformity of the product pursuant to articles L211-1 to L211.18 of the French Consumer Code. The provisions related to your statutory rights are reproduced below:

Article L. 211-4 of the Consumer Code: The seller must deliver goods which are in conformity with the contract and is liable for any lack of conformity which exists at the time the goods were delivered. He is also liable for any lack of conformity resulting from the packaging, installation instructions, installation, if installation were made by the seller or under his responsibility.



Charging Equipment Limited Warranty

Article L. 211-5 of the Consumer Code: To be in conformity with the contract, goods must: (1) be fit for the purposes for which goods of the same type are normally used, and: (i) comply with the description given by the seller and possess the quality of the goods which the seller has held out to the consumer as a sample or model; (ii) show the quality and performance which are normal in goods of the same type and which the consumer can reasonably expect, given the nature of the goods and taking into account any public statements on the specific characteristics of the goods made about them by the seller, the producer or his representative, particularly in advertising or on labeling; or (2) comply with the characteristics agreed mutually by the parties or fit for any particular purpose for which the consumer requires them and which he made known to the seller at the time of conclusion of the contract and which the seller has accepted.

Article L. 211-12 of the Consumer Code: The action resulting from the lack of conformity must be brought by the buyer within two years as from delivery of the goods.

Article 1641 of the Civil Code: A seller is bound to a warranty on account of the latent defects of the thing sold which render it unfit for the use for which it was intended, or which so impair that use that the buyer would not have acquired it, or would only have given a lesser price for it, had he known of them.

Article 1648, paragraph 1, of the Civil Code: The action resulting from redhibitory vices must be brought by the buyer within a period of two years following the discovery of the vice.

Italy

The Charging Equipment Limited Warranty does not modify, affect or substitute your rights under Italian statutory consumer protection laws.

Tesla Motors Netherlands B.V., with its principal office located at Atlasstraat 7-9, 5047 RG, Tilburg, Netherlands ("Tesla") warrants to you, the original retail purchaser ("you"), that the Tesla connector or adapter will, under normal use, be free from lacks of conformity for a period of two (2) years starting from date of the delivery.

The legal warranty established by Sections 129, 130 and 132 of Italian Consumer Code (Legislative Decree of September 6th, 2005, no. 206) applies to the sale of the Tesla connector or adapter. Therefore you have the right to have the Tesla connector or adapter brought into conformity free of charge by repair or replacement at your election, unless the remedy requested is impossible or not proportionate; in case of failure of one of the remedies above, you have the right to an appropriate price-reduction or the right to terminate the agreement. Unless it is proven otherwise, it shall be assumed that the defects arising no later than six (6) months after the delivery of the Tesla connector or adapter already existed on the date of delivery. You will not be entitled to exercise the above rights in case of failure to notify Tesla of the lack of conformity within two (2) months starting from the date on which you detected such lack of conformity. In any event, the right to file a complaint before the Courts intended to assert a lack of conformity not maliciously concealed by Tesla shall automatically expire twenty-six (26) months after the delivery of the Tesla connector or adapter.

Poland

The Charging Equipment Limited Warranty does not modify, affect or substitute your Polish statutory consumer protection laws, including under the Polish Act on specific terms and conditions of consumer sale and amendments to the Civil Code, dated 27 July 2002.



San Marino

Specific Approval of Clauses by Purchaser

As a purchaser of a Tesla connector or adapter, you expressly agree to the following clauses in the Charging Equipment Limited Warranty:

- General terms;
- Limits of liability;
- Warranty enforcement laws and dispute resolution; and
- Country-Specific Consumer Disclosures.



B

- bottom or rear entry
 - configurations, dimensions and spacing 9
 - example of the service wiring 17
 - installing the low profile bracket for 14

C

- cardboard template, using the 14
- cautions 3
- check the box contents 11
- circuit breaker
 - corresponding rotary switch settings 19
 - requirements 8
- circuit ratings, optional 6
- conduit, about 9
- connect the wiring 17
- copyrights 2
- cover
 - removing the outer 16
 - removing the sealing 16
 - securing the outer 20

D

- dimensions 5
- DIP switches, configuring 19
- documentation errors, sending feedback 2

F

- features
 - circuit ratings, optional 6
 - load sharing 6
 - recovery from power outages 6
 - self-monitoring and recovery 6

I

- installation
 - for rear or bottom entry wiring 14
 - for top entry wiring 15
 - information, about 2
 - planning your 7
 - preparing for 16
 - tools and materials required 13
 - torque recommendations 17
- installation overview 13
- installation, testing 26

L

- lights, diagnostic 6
- lights, LED 21
- load sharing
 - configuring the DIP and rotary switches 19
 - example of the communication wiring 28
- low profile bracket
 - installing the 14

M

- minimum requirements 7

N

- notes 4

P

- planning your installation
 - circuit breaker requirements 8
 - location of the wall connectors 8
 - minimum requirements 7
 - service wiring 7
 - types of installations 9
- power outages, recovery from 6
- power ratings 5
- power up 20
- product specifications 2
- publications and video, downloading 5

R

- removing the outer cover 16
- reset button 6, 24, 26
- rotary switches, configuring 19

S

- safety instructions 3, 4
- securing the outer cover 20
- self-monitoring and recovery 6
- service wiring 7, 17
- set the operating current 19
- specifications
 - dimensions 5
 - power ratings 5
 - temperature limits 5
- SRRC diagram (China only) 29



T

- temperature limits 5
- terminal blocks
 - connecting the service wiring to the 17
 - torque recommendations 17
- Tesla, contacting 25
- testing for proper operation 26
- top entry
 - bracket, installing the 15
 - configurations, dimension and spacing 9
 - example of the service wiring 17
 - wiring, installing the top entry bracket for 15
- trademarks 2
- troubleshooting 21, 24, 25, 27

W

- wall connectors
 - checking the box contents 11
 - connecting the terminal blocks 27
 - daisy chaining 27
 - example of the communication wiring 28
 - location of 8
 - optional configuration 27
 - power up 20
 - reset 24, 26
 - troubleshooting 27
- warnings 3
- wiring for load sharing 27

TESLA

P/N: 1069746-00-C

MNL, USER GUIDE, EU, 3PH, 32A, HW, WC, GEN2



(P) PN: 1069746-00-C
(T) TLN: TT32AMP3EU